

ULTRA
MOBILI

G



GRANDE! significa forme sinuose, volumi bold, finiture esclusive, qualità senza compromessi e un'attenzione tutta contemporanea alla funzionalità

GRANDE! means architectural vocation, sinuous forms, bold volumes, exclusive finishes, uncompromising quality, and an all-contemporary focus on functionality

GRANDE! est synonyme de vocation architecturale, de formes sinueuses, de volumes audacieux, de finitions exclusives, d'une qualité sans compromis et d'une fonctionnalité toute contemporaine

GRANDE!

LINEA DI DESIGN / DESIGN LINE

DESIGN D'AVANGUARDIA, MATERIALI RICERCATI, FORME ICONICHE, MOOD ULTRAMODERNO. UN VIAGGIO APPASSIONANTE NELLE ATMOSFERE MODERNISTE DEL XX SECOLO RIVISITATE ATTRAVERSO UNO SGUARDO CONTEMPORANEO. **GRANDE! SIGNIFICA VOCAZIONE ARCHITETTONICA, FORME SINUOSE, VOLUMI BOLD, FINITURE ESCLUSIVE, QUALITÀ SENZA COMPROMESSI E UN'ATTENZIONE TUTTA CONTEMPORANEA ALLA FUNZIONALITÀ. UN PENSIERO DINAMICO CHE RIVOLUZIONA L'ARTE DI VIVERE GLI INTERNI. / **AVANT-GARDE DESIGN**, SOPHISTICATED MATERIALS, ICONIC FORMS, ULTRA-MODERN MOOD. AN EXCITING JOURNEY INTO THE MODERNIST ATMOSPHERES OF THE 20TH CENTURY REVISITED THROUGH A CONTEMPORARY GAZE. GRANDE! MEANS ARCHITECTURAL VOCATION, SINUOUS FORMS, BOLD VOLUMES, EXCLUSIVE FINISHES, UNCOMPROMISING QUALITY, AND AN ALL-CONTEMPORARY FOCUS ON FUNCTIONALITY. DYNAMIC THINKING THAT REVOLUTIONIZES THE ART OF INTERIOR LIVING. / DESIGN D'AVANT-GARDE, MATÉRIAUX SOPHISTIQUÉS, FORMES ICONIQUES, AMBIANCE ULTRAMODERNE. UN VOYAGE PASSIONNANT DANS LES ATMOSPHÈRES MODERNISTES DU XXE SIÈCLE REVISITÉES PAR UN REGARD CONTEMPORAIN. GRANDE! EST SYNONYME DE VOCATION ARCHITECTURALE, DE FORMES SINUEUSES, DE VOLUMES AUDACIEUX, DE FINITIONS EXCLUSIVES, D'UNE QUALITÉ SANS COMPROMIS ET D'UNE FONCTIONNALITÉ TOUTE CONTEMPORAINE. **UNE PENSÉE DYNAMIQUE** QUI RÉVOLUTIONNE L'ART DE VIVRE À L'INTÉRIEUR. / AVANTGARDISTISCHES DESIGN, RAFFINIERTE MATERIALIEN, **IKONISCHE FORMEN**, ULTRAMODERNES AMBIENTE. EINE AUFREGENDE REISE IN DIE MODERNISTISCHEN ATMOSPHÄREN DES 20. JAHRHUNDERTS, DIE DURCH EINEN ZEITGENÖSSISCHEN BLICK NEU BELEUCHTET WERDEN. GRANDE! BEDEUTET ARCHITEKTONISCHE BERUFUNG, GESCHWUNGENE FORMEN, KÜHNE VOLUMINA, EXKLUSIVE OBERFLÄCHEN, KOMPROMISSLOSE QUALITÄT UND EINE GANZ UND GAR ZEITGEMÄÙE AUSRICHTUNG AUF FUNKTIONALITÄT. EIN DYNAMISCHES DENKEN, DAS DIE KUNST DES WOHNENS REVOLUTIONIERT.**

INDICE / INDEX

MINA	LIBRERIA / LIBRARY	06
VENUS	CREDENZA / SIDEBOARD	22
	- VENUS GRADIENT	26
	- VENUS G	30
	- VENUS D	36
MARTE	MADIA / LOW SIDEBOARD	40
REGIS	MOBILE BAR / BAR CABINET	48
	- VINTAGE METAL EFFECT FINISH	50
	- GRADIENT FINISH	52
	- GLOSS FINISH	60
ZEUS	TAVOLO / TABLE	62
ARES	TAVOLO / TABLE	74
CRONO	TAVOLO / TABLE	82
PERSEO	CONSOLE	88
MITO	TAVOLO / TABLE	94
	- MITO ROVERE	100
	- MITO CANALETTO	104
	- TAVOLINI / OCCASIONAL TABLES	104
ERACLE	TAVOLINI / COFFEE TABLES	108
CRETA	CONSOLE	112

ULTRA
MOBILI

**VOLUMI
ARCHITETTONICI,
FORME MORBIDE E
AVVOLGENTI, INDOLE
DECISA, DIMENSIONI
BOLD.**



MINA LIBRERIA / BIBLIOTHÈQUE / LIBRARY

FINITURA LACCATA CON INSERTI NOCE CANALETTO / FINITION LAQUÉE AVEC INSERTS EN NOYER NOIR / LACQUER FINISH WITH BLACK WALNUT INSERTS



MINA 220



Volumi architettonici, forme morbide e avvolgenti, indole decisa, dimensioni bold. MINA è un arredo dalla presenza scenica innata, un'icona assoluta, una splendida diva.

Architectural volumes, soft and enveloping shapes, a decisive character, bold dimensions. MINA is a piece of furniture with an innate stage presence, an absolute icon, a stunning diva.

Des volumes architecturaux, des formes douces et enveloppantes, un caractère décisif, des dimensions audacieuses. MINA est un meuble qui a une présence scénique innée, une icône absolue, une diva éblouissante.



ARCHITECTURAL VOLUMES,
SOFT AND ENVELOPING
SHAPES, A DECISIVE
CHARACTER, BOLD
DIMENSIONS.

MINA 150



MINA TV SHELF

MINA C90

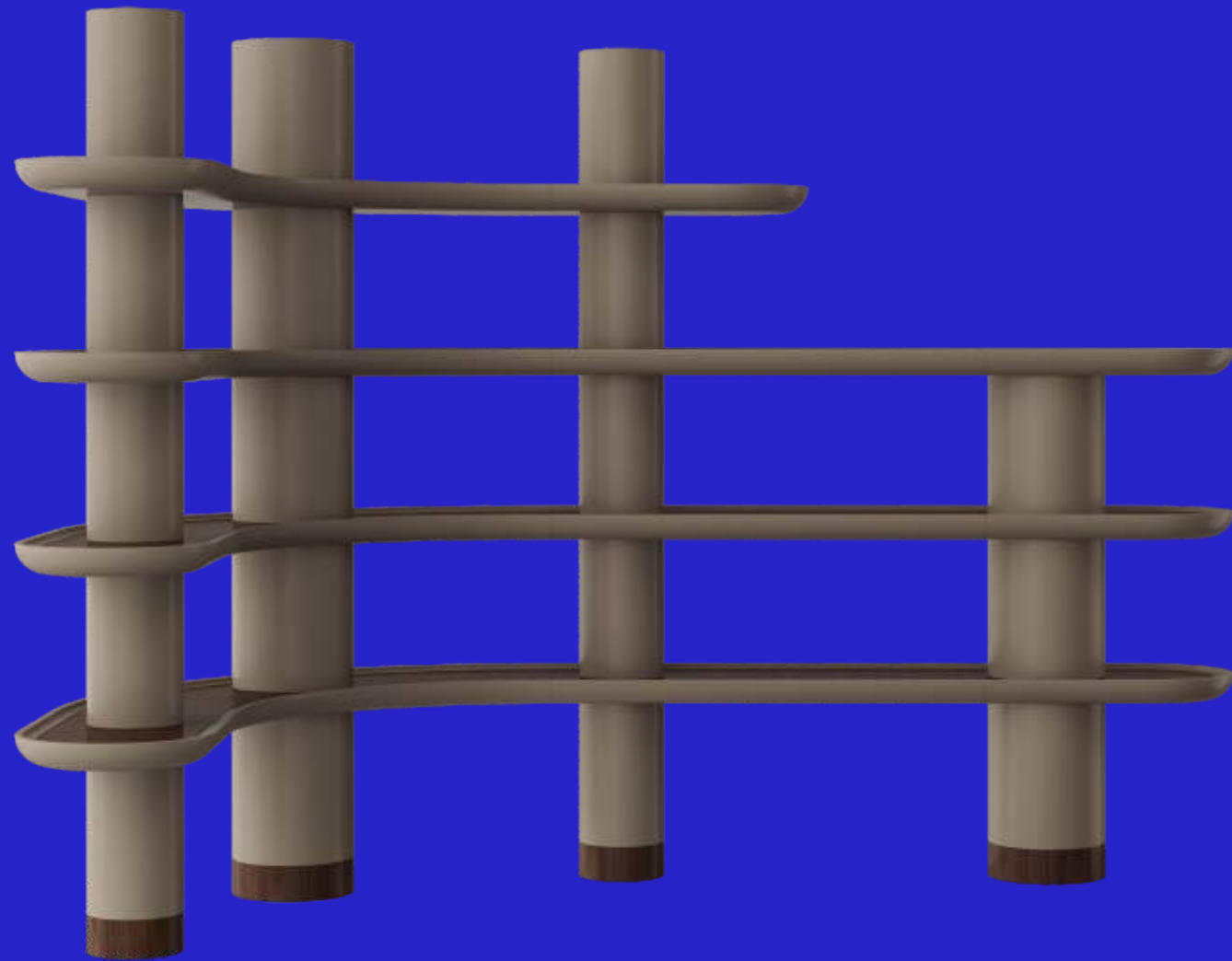

MINA R140

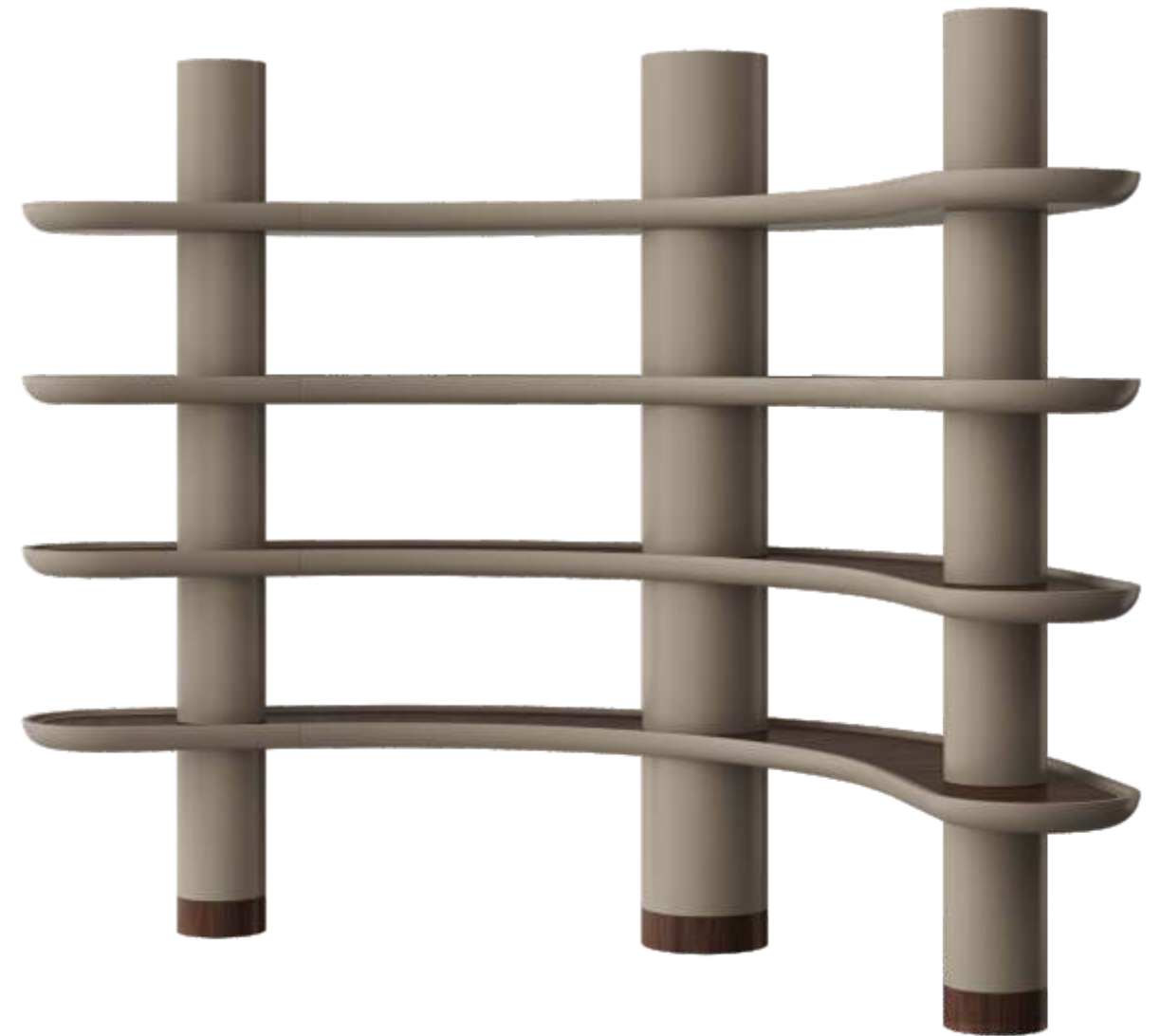

**DES VOLUMES ARCHITECTURAUX, DES FORMES DOUCES ET ENVELOPPANTES,
UN CARACTÈRE DÉCISIF, DES DIMENSIONS AUDACIEUSES.**





MINA LIBRERIA / BIBLIOTHÈQUE / LIBRARY

VINTAGE METAL EFFECT LACQUER FINISH / FINITURA LACCATA EFFETTO METALLO VINTAGE / FINITION LAQUÉE EFFET MÉTAL VINTAGE

MINA LIBRARY

COD.GRD02

FINITURE | FINISHES

FINITURA DELLA STRUTTURA
STRUCTURE FINISH
FINITION DE LA STRUCTURE

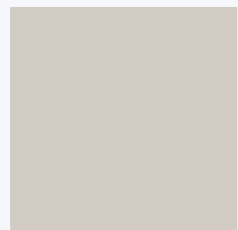

LO | GREIGE LACCATO OPACO



BR | BRONZE EFFECT PAINT

FINITURA INSERTI
INSERTS FINISH
FINITION des INSERTS

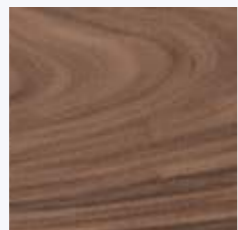

NC | NOCE CANALETTO



CB | CERAMIC TILE

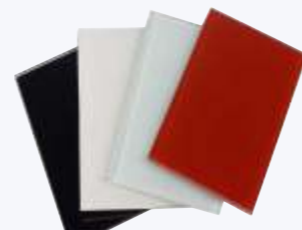

VL | VETRO LACCATO

FINITURA PIEDI
FEET FINISH
FINITION des PIEDS

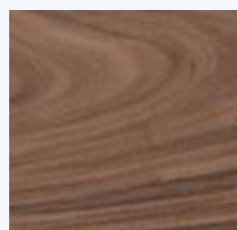

NC | NOCE CANALETTO

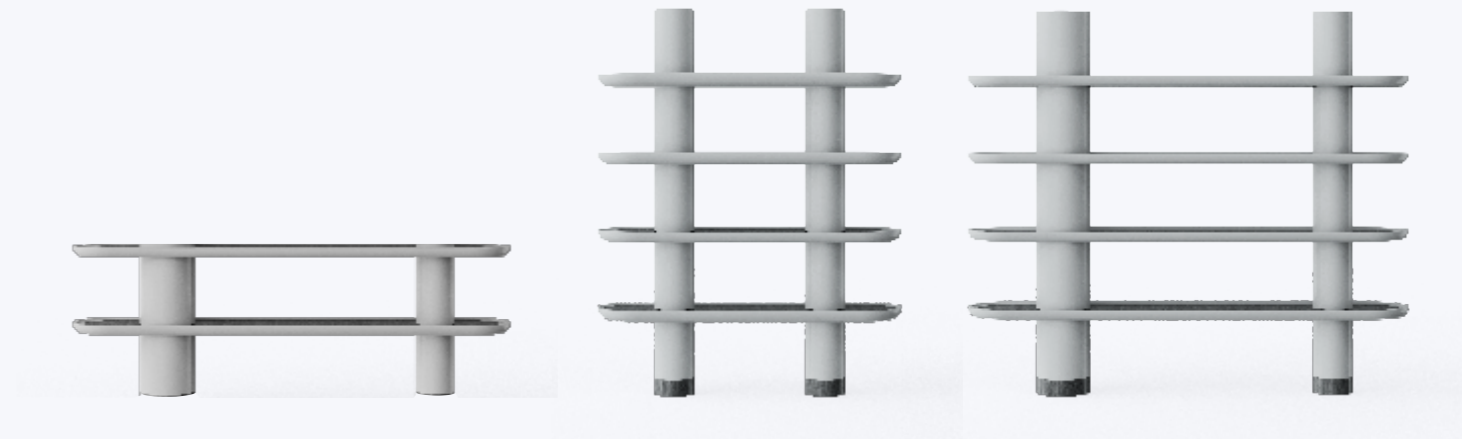

librerie standard / standard libraries

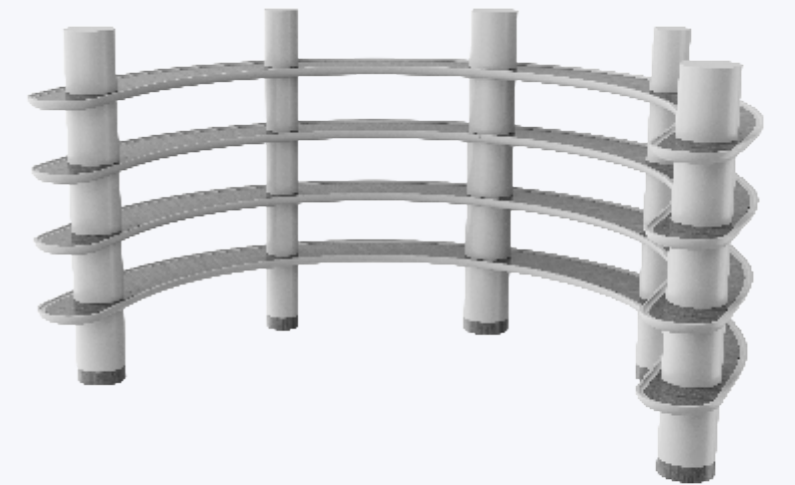

librerie standard / standard libraries

DESCRIZIONE
DESCRIPTION
DESCRIPTION

Libreria componibile con ripiani spessore 60 mm e colonne-cilindri D200 e D280. Struttura laccata, inserti in legno, ceramica o vetro laccato. Illuminazione a LED, carica batteria da incasso come opzione.

Modular library with 60 mm thickness shelves and columns D200 and 280 mm. Lacquered structure, wooden, ceramic or lacquered glass inserts. LED lighting, build-in charges as an option.

Bibliothèque modulaire avec étagères de 60 mm d'épaisseur et cylindres à colonnes D200 et D280. Structure laquée, inserts bois, céramique ou verre laqué. Eclairage LED, chargeur de batterie encastré en option.

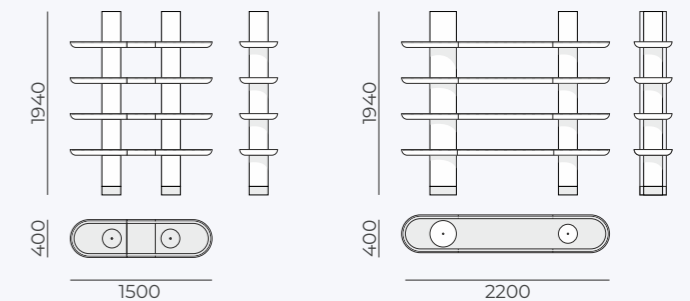

LINEARITÀ SOFT,
INDOLE ETEREA E
IMPALPABILE, ELEGANZA
ALLO STATO PURO IN UNA
CIFRA STILISTICA
INEDITA.

VENUS CABINET / MOBILE / ARMOIRE

MATT LACQUERED FINISH - CANALETTO WALNUT INSERTS / FINITURA LACCATA OPACA - INSERTI NOCE CANALETTO / FINITION LAQUÉE MATE - INSERTS EN NOYER CANALETTO



VENUS

SOFT LINEARITY, AN
ETHEREAL AND IMPALPABLE
CHARACTER, PURE
ELEGANCE IN AN
UNPRECEDENTED STYLISTIC
SIGNATURE.



VENUS Mobile a 4 ante con bordi ed angoli arrotondati. Struttura laccata in finitura opaca o lucida. Interno mobile con cassetto in legno o laccato e ripiani. Basamento cilindrico realizzato in metallo e verniciato a liquido.

VENUS 4-doors cabinet with rounded edges and corners. Lacquered structure in mat or gloss finish. Cabinet interior with wooden or lacquered drawer and shelves. Cylindrical base made of metal and liquid lacquered.

Meuble buffet 4 portes VENUS avec bords et angles arrondis. Structure laquée en finition mate ou brillante. Intérieur du meuble avec tiroirs et étagères en bois ou laqué. Base cylindrique en métal verni liquide.



VENUS GRADIENT BG

HAND-SHADED MATTE LACQUER FINISH / FINITURA LACCATA OPACA SFUMATA A MANO / FINITION LAQUÉE MATE NUANCÉE À LA MAIN / HAND-SHADED MATTE



LINEA **GRANDE**

VENUS GRADIENT



VENUS GRADIENT è una credenza elegante e contemporanea caratterizzata dall'alta qualità della laccatura sfumata. Meticolosamente fatta a mano dai nostri artigiani questa tecnica è una transizione di un colore ad un altro.

VENUS GRADIENT is an elegant and contemporary sideboard characterized by the high quality of the shaded lacquer used. Meticulously handmade by our craftsmen this technique is a beautiful transition from one color to another.

VENUS GRADIENT est un buffet élégant et contemporain caractérisé par la haute qualité de la laque nuancée utilisée. Réalisée méticuleusement par nos artisans, cette technique permet une belle transition d'une couleur à l'autre.



VENUS G

ANTE DAL DESIGN GRAFICO FINITURA LACCATA OPACA / DOORS WITH A GRAPHIC DESIGN AND MATTE LACQUERED FINISH / PORTES AVEC GRAPHISME FINITION LAQUÉE MATE



VENUS G



VENUS G Credenza laccata con 4 ante fresate a disegni geometrici. Basamenti in metallo laccato con forma cilindrica e zoccolo sagomato laccato in contrasto. Interno mobile con cassetto e ripiani. Finitura laccata opaca o lucida.

VENUS G Lacquered sideboard 4 milled doors with geometric designs. Lacquered metal bases with cylindrical shape and contrasting lacquered shaped feet. Cabinet interior with drawer and shelves. Mat or gloss lacquer finish.

VENUS G Buffet laqué 4 portes fraisées à motifs géométriques. Piétements en métal laqué de forme cylindrique et plinthe façonnée en laque contrastée. Intérieur du meuble avec tiroir et étagères. Finition laquée mate ou brillante.



UNE DOUCE LINÉARITÉ, UN CARACTÈRE
ÉTHÉRÉ ET IMPALPABLE, UNE ÉLÉGANCE
PURE DANS UNE SIGNATURE STYLISTIQUE
SANS PRÉCÉDENT.





VENUS D

FINITURA LACCATA OPACA – INSERTI SPECCHIO DICROICO / MATT LACQUER FINISH – DYCHROIC MIRROR INSERTS / FINITION LAQUÉE MATE - INSERTS EN MIROIR DICHOÏQUE

**VOLUMI COMPATTI E
AVVOLGENTI,
PRESENZA RIGOROSA
E DECISA, MATERICITÀ
FLUIDA E VELLUTATA.**

*MARTE è l'archetipo
della solidità in un
mood raffinato e
seducente.*



LINEA **GRANDE**

MARTE LOW CABINET

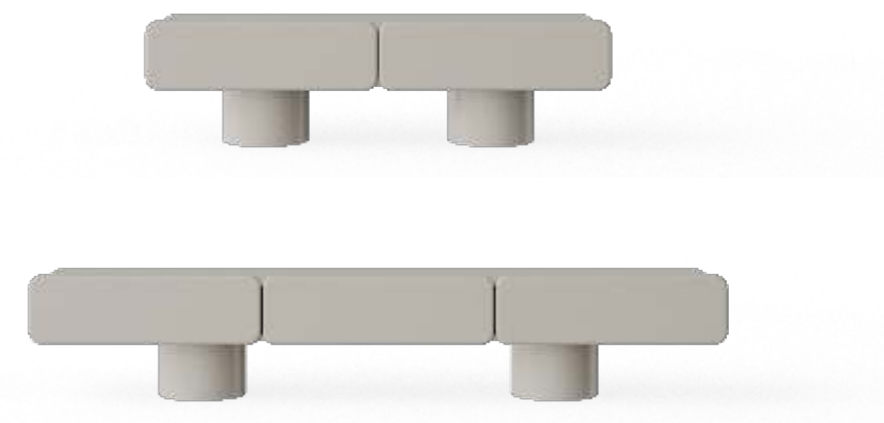

Contenitore basso con 2 o 3 cassetti e gambe rotonde. Cassetti frontali con angoli stondati. Finitura laccata opaca o lucida.

Low sideboard with 2 o 3 drawers and round legs. Rounded fronts and angles. Mat or gloss lacquer finish.

Meuble de rangement bas avec 2 ou 3 tiroirs et pieds ronds. Façades de tiroirs à coins arrondis. Finition laquée mate ou brillante.

COMPACT AND ENVELOPING VOLUMES,
RIGOROUS AND DECISIVE PRESENCE, FLUID
AND VELVETY MATERIALITY.

*MARTE is the archetype of solidity
in a refined and seductive mood.*



DES VOLUMES COMPACTS ET ENVELOPPANTS, UNE PRÉSENCE RIGOUREUSE ET DÉCISIVE, UNE MATÉRIALITÉ FLUIDE ET VELOUTÉE.

MARTE est l'archétype de la solidité dans une ambiance raffinée et séduisante.

MARTE STORAGE UNIT / CONTENITORE BASSO /CONTENEUR BAS

MATT OR GLOSS LACQUERED FINISH / FINITURA LACCATA OPACA O LUCIDA / FINITION LAQUÉE MATE OU BRILLANTE / MATT OR GLOSS LACQUERED FINISH / FINITURA LACCATA

VENUS CABINET

COD.GRD01



MARTE STORAGE UNIT

COD.GRD03

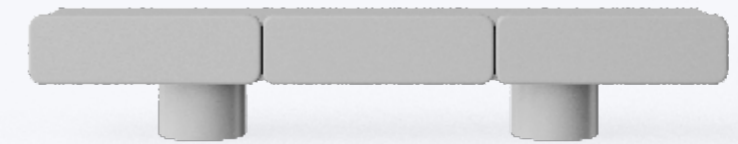

FINITURE | FINISHES

FINITURA DELLA STRUTTURA
STRUCTURE FINISH
FINITION DE LA STRUCTURE

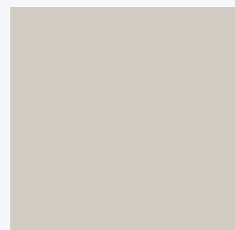

LO | LACCATO OPACO



BR | BRUSHED BRONZE

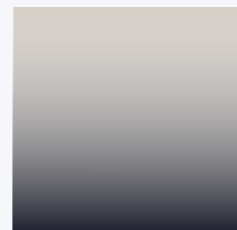

LG | GRADIENT 5004-6073

FINITURA INSERTI ANTE
DOORS' INSERT FINISH
FINITION des INSERTS de PORTE

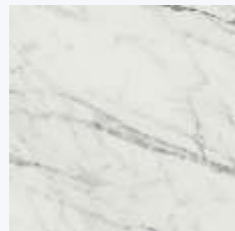

CB | CERAMIC TILE

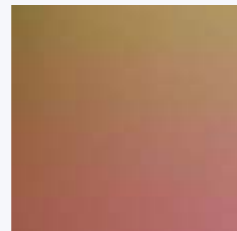

DC | DICHROIC MIRROR

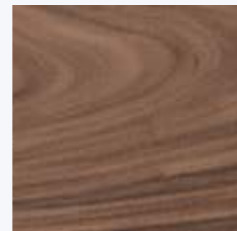

NC | NOCE CANALETTO

FINITURA PIEDI
FEET FINISH
FINITION des PIEDS



BB | BRUSHED BRASS

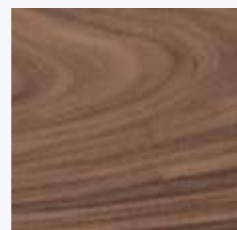

NC | NOCE CANALETTO

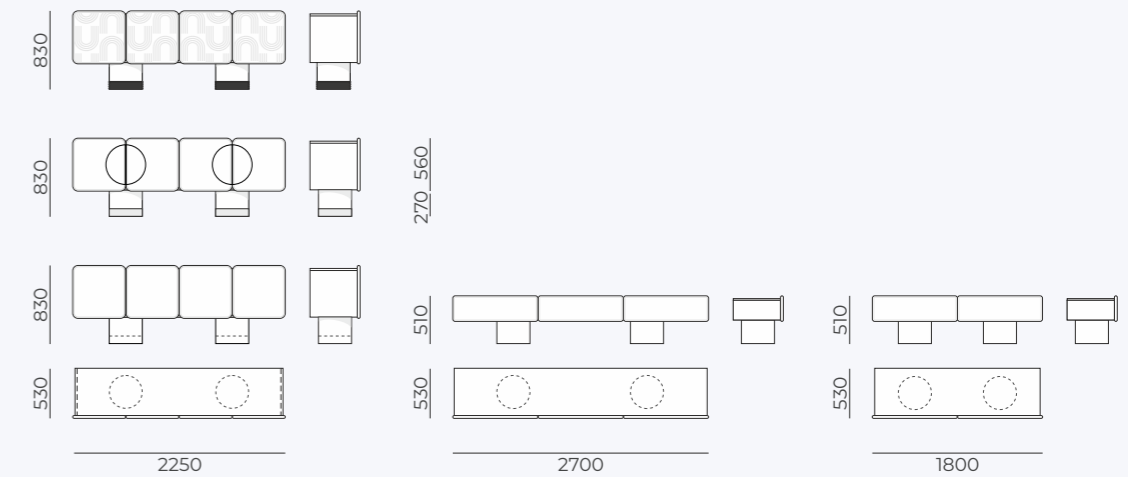

DESCRIZIONE
DESCRIPTION
LA DESCRIPTION

Credenze con ante stondate in finitura laccata con o senza inserti (specchio dichroico, noce canaletto). Con o senza piedini (noce canaletto o ottone satinato). Interno mobile con cassetto in legno o laccato e interno rivestito in pelle.

Sideboards with rounded doors in a lacquered finish with or without inserts (dichroic mirror, Canaletto walnut). With or without feet (Canaletto walnut or satin brass). Cabinet interior with wooden or lacquered drawer and leather-covered interior.

Buffets avec portes arrondies en finition laquée avec ou sans inserts (miroir dichroïque, noyer Canaletto). Avec ou sans pieds (noyer Canaletto ou laiton satiné). Cabinet interior with wooden or lacquered drawer and leather-covered interior.



SEGNI GRAFICI
RIGOROSI E MORBIDI
ACCENTI DECORATIVI,
NUANCES ACCESE E
PREZIOSE FINITURE A
CONTRASTO.

*REGIS è l'essenza stessa
della regalità, in una cifra
stilistica sorprendente.*

REGIS MOBILE BAR / BAR CABINET / MEUBLE-BAR

FINITURA LACCATA OPACA EFFETTO METALLO – INSERTI SPECCHIO DICROICO / METAL EFFECT MATT LACQUER FINISH - DYCHROIC MIRROR INSERTS / FINITION LAQUÉE MATE AVEC E

REGIS

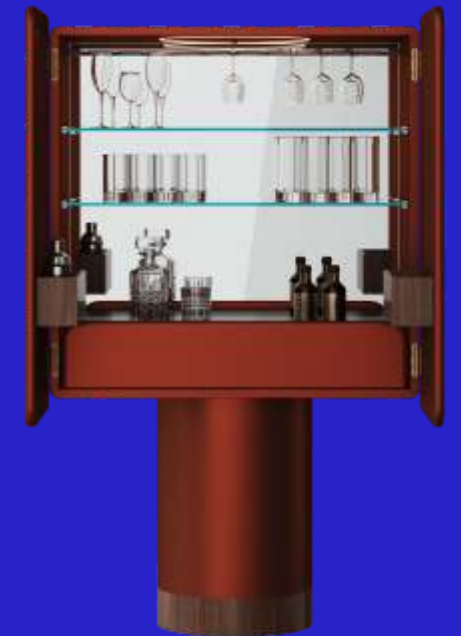
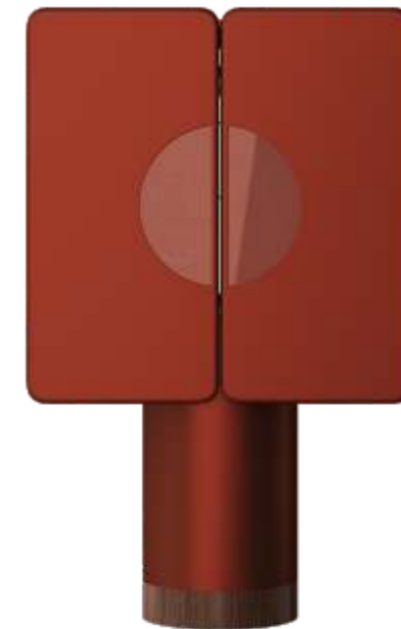
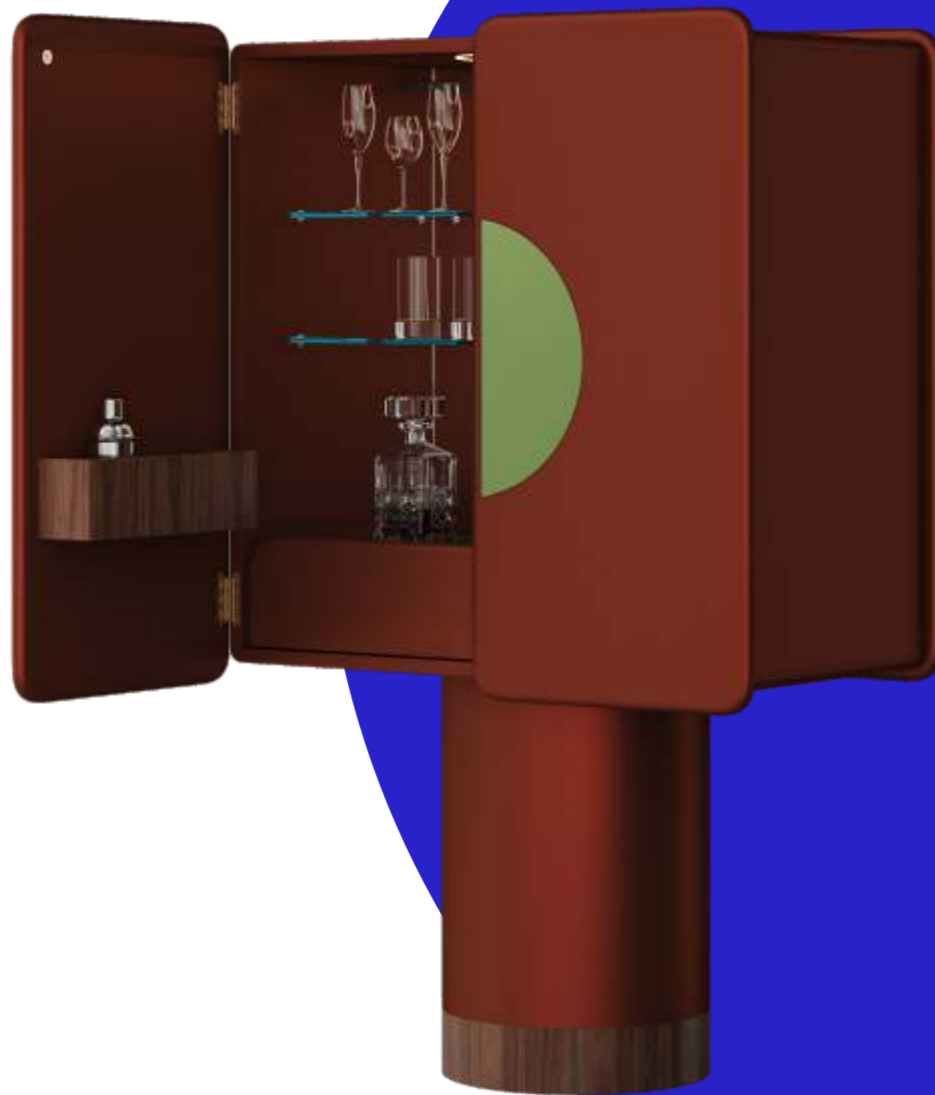

Mobile bar a 2 ante con bordi ed angoli arrotondati, inserti in specchio dichroico, ceramica o legno incassato sul frontale. Struttura laccata in finitura opaca o lucida. Interno mobile con cassetto, ripiano in ceramica effetto marmo. Schienale specchio, ripiani vetro, illuminazione led e portabottiglie nelle ante.

2 doors with rounded edges and corners Bar Cabinet, dichroic mirror inserts, ceramic or wood recessed on the front. Lacquered structure, matte or gloss finish. Cabinet interior: lacquered front drawer, marble effect ceramic shelf. Mirror back, glass shelves, led lighting and bottle holders in the doors.

Meuble bar à 2 portes avec bords et angles arrondis, inserts en miroir dichroïque, céramique ou bois encastrés sur la façade. Structure laquée en finition mate ou brillante. Intérieur du meuble avec tiroir, tablette en céramique effet marbre. Dos en miroir, étagères en verre, éclairage LED et porte-bouteilles dans les portes.



VINTAGE METAL EFFECT FINISH

Finitura laccata a mano effetto bronzo vintage per mobile bar REGIS con piastrelle con effetto marmo Sahara Noir.

Vintage Bronze Effect handmade laquer finish for REGIS Bar Cabinet with Sahara Noir marble effect tile.



Finition laquée à la main effet bronze vintage pour le meuble bar REGIS avec carrelage effet marbre Sahara Noir.



REGIS GRADIENT

HAND-SHADED MATTE LACQUER FINISH / FINITURA LACCATA OPACA SFUMATA A MANO / FINITION LAQUÉE MATE NUANCÉE À LA MAIN / HAND-SHADED MATTE



LINEA **GRANDE**

REGIS GRADIENT

**RIGOROUS GRAPHIC SIGNS AND SOFT
DECORATIVE ACCENTS, BRIGHT NUANCES
AND PRECIOUS CONTRASTING FINISHES.**

*REGIS is the very essence of royalty, in a striking
stylistic signature.*



La finitura laccata GRADIENT è un efficace passaggio da un colore all'altro, dal blu-nero (scuro) fino al greige chiaro. Tecnica meticolosamente artigianale.

Lacquered finish GRADIENT is an effective transition from one color to another, from dark Black Blue till light Greige color. Meticulously handmade technique.

La finition laquée GRADIENT permet de passer efficacement d'une couleur à l'autre, du bleu noir foncé au grège clair. Technique méticuleusement réalisée à la main.





REGIS GLOSS LACQUER

FINITURA LACCATA LUCIDA / HI GLOSS LACQUER FINISH / FINITION LAQUÉE HAUTE BRILLANCE / FINITURA LACCATA LUCIDA / HI GLOSS LACQUER FINISH / FINITION

SIGNES GRAPHIQUES RIGOUREUX ET ACCENTS DÉCORATIFS DOUX, NUANCES LUMINEUSES ET FINITIONS PRÉCIEUSES ET CONTRASTÉES.

REGIS, c'est l'essence même de la royauté, dans une signature stylistique saisissante.



REGIS BAR CABINET

COD.GRDBAR

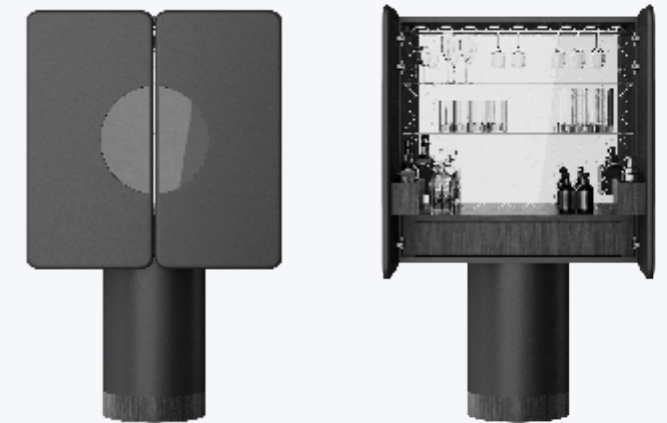

FINITURE | FINISHES

FINITURA DELLA STRUTTURA
STRUCTURE FINISH
FINITION DE LA STRUCTURE

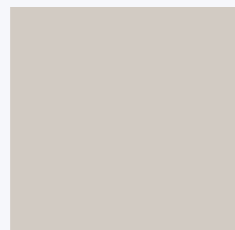

LO | GREIGE LACCATO OPACO



BR | BRUSHED BRONZE

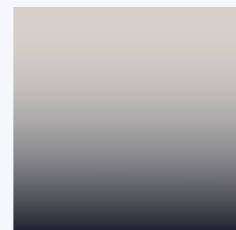

BC | GRADIENT 5004-6073

FINITURA INSERTI
INSERTS FINISH
FINITION des INSERTS

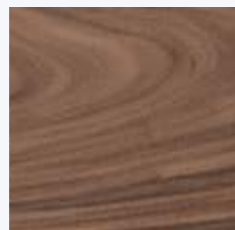

NC | NOCE CANALETTO

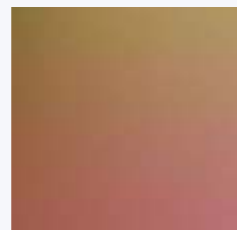

DC | DICHROIC MIRROR

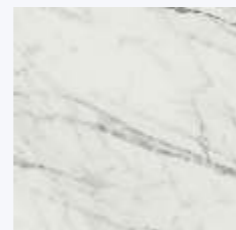

CB | CERAMIC TILE

FINITURA PIEDI
FEET FINISH
FINITION des PIEDS

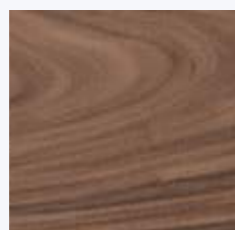

NC | NOCE CANALETTO



BB | BRUSHED BRASS

DESCRIZIONE
DESCRIPTION
LA DESCRIPTION

Mobile Bar a due ante con gamba cilindrica. Cassetto interno, specchio, ripiani in vetro, tasche laterali. Illuminazione a LED opzionale. Finitura laccata opaca con inserti anta in specchio dicroico o ceramica/legno.

Bar Cabinet with two doors and leg-cylinder. Internal drawer, mirror, glass shelves, side pockets. LED lighting and accessories optionally. Matt Lacquer finish with door inserts in dichroic mirror or ceramic or wood.

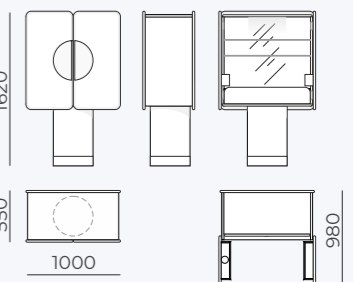

Armoire de bar à deux portes avec pied cylindrique. Tiroir interne, miroir, étagères en verre, poches latérales. Éclairage LED en option. Finition laquée mate avec inserts de porte en miroir dichroïque ou en céramique.

**PRESENZA SCULTOREA, FORME ORGANICHE
ED AVVOLGENTI, PREZIOSITÀ MATERICA E
INDOLE DA PROTAGONISTA.**

*ZEUS è un inno alla convivialità, l'arte dello stare
insieme come paradigma di vita.*

ZEUS TAVOLO / DINING TABLE / TABLEAU

VINTAGE METAL EFFECT LACQUER FINISH / FINITURA LACCATA EFFETTO METALLO VINTAGE / FINITION LAQUÉE EFFET MÉTAL VINTAGE

ZEUS BRONZE



Finitura laccata a mano
effetto metallo bronzo.

Tavolo da pranzo ovale con
tre gambe-colonne, piano
con bordo arrotondato.

Hand painting: Vintage
Bronze Metal Paint Effect
finish.

Oval dining table with
three legs-columns,
rounded edge top.

Finition laquée à la main
avec effet métal bronze.

Table de salle à manger
ovale à trois pieds-
colonnes, plateau à bord
arrondi.



ZEUS TABLE

SCULPTURAL PRESENCE, ORGANIC AND ENVELOPING FORMS, MATERIAL PRECIOUSNESS AND PROTAGONIST CHARACTER.

ZEUS is a hymn to conviviality, the art of being together as a paradigm of life.



Tavolo da pranzo ovale con tre gambe-colonne, piano a bordo stondato con inserti in marmo: D90 + D20 cm

Oval dining table with three legs-columns, rounded edge top with marble inserts: D90 + D20 cm

Table de salle à manger ovale à trois pieds-colonnes, plateau à bord arrondi et inserts en marbre: D90 + D20 cm

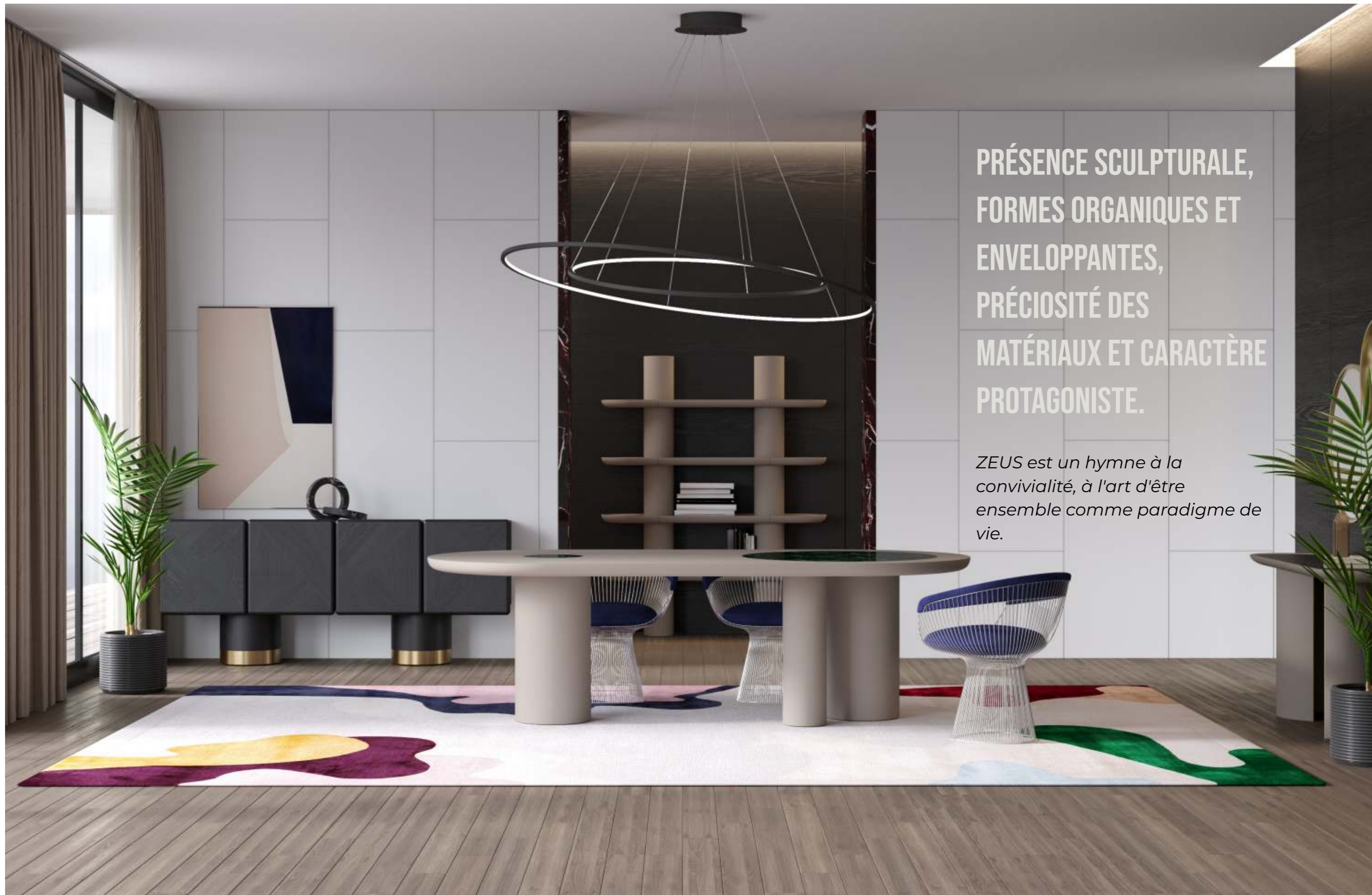

PRÉSENCE SCULPTURALE,
FORMES ORGANIQUES ET
ENVELOPPANTES,
PRÉCIOSITÉ DES
MATÉRIAUX ET CARACTÈRE
PROTAGONISTE.

*ZEUS est un hymne à la
convivialité, à l'art d'être
ensemble comme paradigme de
vie.*

ZEUS

NOCE CANALETTO / BLACK WALNUT

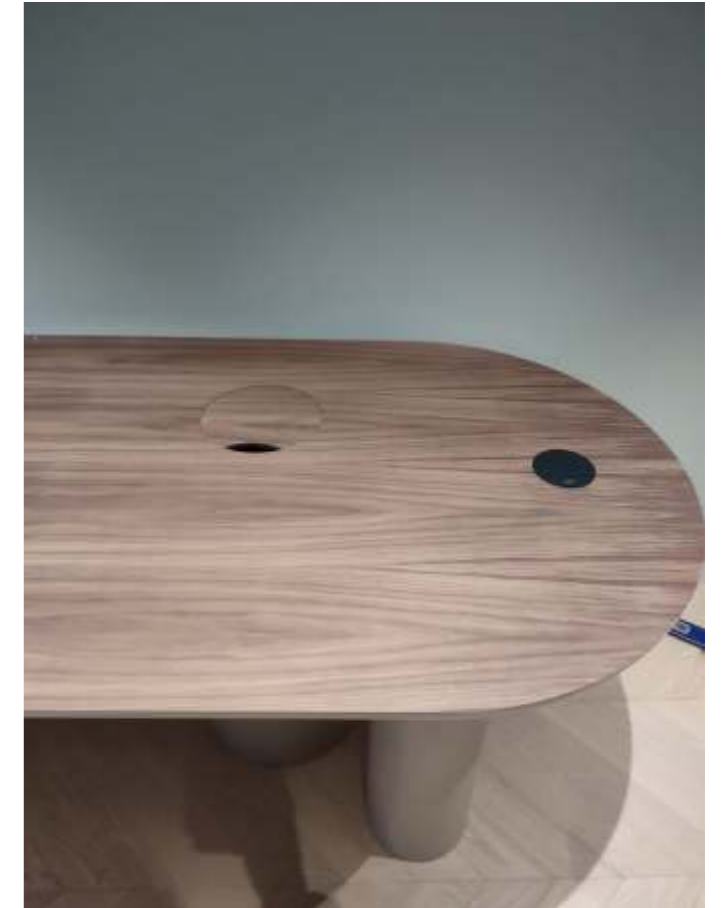

ZEUS TABLE

COD.GRD04



FINITURE | FINISHES

FINITURA DELLA STRUTTURA
STRUCTURE FINISH
FINITION DE LA STRUCTURE

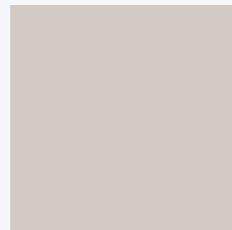

LO | LACCATO OPACO

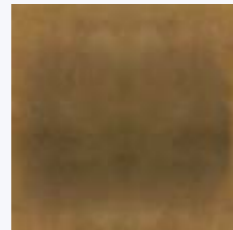

BR | BRONZE EFFECT PAINT

FINITURA PIANA / INSERTI
TOP / INSERTS FINISH
FINITION PLATE / INSERTS

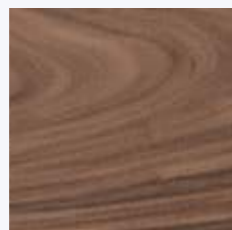

NC | NOCE CANALETTO

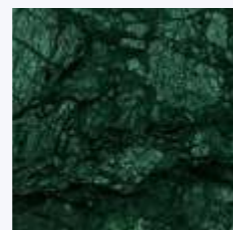

VG | VERDE GUATEMALA

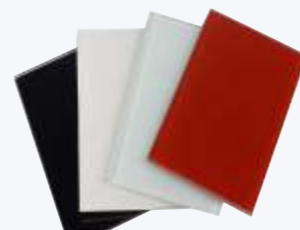

VL | VETRO LACCATO

DESCRIZIONE
DESCRIPTION
LA DESCRIPTION

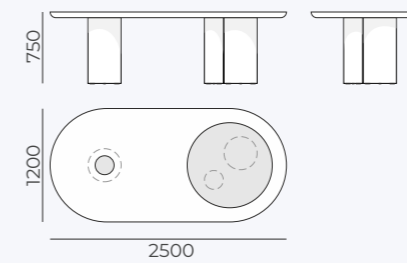

Tavolo da pranzo ovale con tre gambe-colonne, piano a bordo stondato con o senza inserti in marmo.

Oval dining table with three legs-columns, rounded edge top with or without marble inserts.

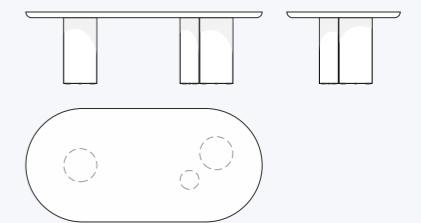

Table ovale à trois pieds-colonnes, plateau à bord arrondi avec ou sans inserts en marbre.

LINEARITÀ RIGOROSA E ACCENTI MORBIDI,
MOOD ESSENZIALE E UNA PRESENZA NELLO
SPAZIO MONUMENTALE E LEGGERA.

*ARES celebra la convivialità più autentica
attraverso la forza espressiva della semplicità.*



ARES TAVOLO / DINING TABLE / TABLEAU

ROVERE NATURALE - ROVERE NERO FINITURA / NATURAL OAK - BLACK OAK FINISH / CHÊNE NATUREL - CHÊNE NOIR FINITION / ROVERE NATURALE - ROVERE NERO FINITURA



ARES

STRICT LINEARITY AND SOFT ACCENTS, AN ESSENTIAL MOOD AND A MONUMENTAL, LIGHT PRESENCE IN SPACE.

ARES celebrates authentic conviviality through the expressive power of simplicity.



Tavolo da pranzo con struttura in legno, gambe arrotondate ed elemento di collegamento in metallo.

Dining table with wooden structure, rounded legs and metal connecting element.

Table de salle à manger avec structure en bois, pieds arrondis et élément de liaison en métal.

UNE LINÉARITÉ STRICTE ET DES ACCENTS
DOUX, UNE AMBIANCE ESSENTIELLE ET
UNE PRÉSENCE MONUMENTALE ET
LÉGÈRE DANS L'ESPACE.



***ARES** célèbre la convivialité authentique par la
force expressive de la simplicité.*



ARES TABLE

COD.TAR



FINITURE | FINISHES

FINITURA DEL TOP
TOP FINISH
FINITION SUPÉRIEURE

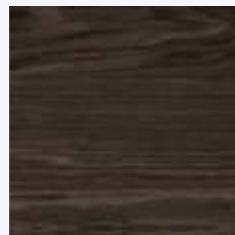

RB | ROVERE NERO

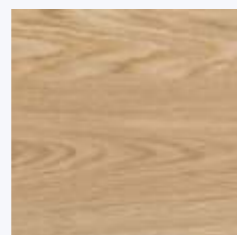

RN | ROVERE NATURALE

FINITURA METALLO
METAL FINISH
FINITION MÉTALLIQUE

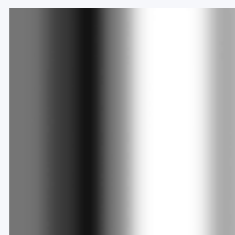

GR | CHROME



BM | BLACK METAL

DESCRIZIONE
DESCRIPTION
LA DESCRIPTION

Tavolo da pranzo in essenza di legno. Piano con bordi arrotondati, 4 gambe cilindriche con struttura metallica di collegamento.
Finiture: rovere nero o rovere naturale
Finitura metallo: cromo o nero

Wood essence dining table. Rounded edges top, 4 cylindered legs with connecting metal structure.
Finishes: Oak Black or Natural Oak
Metal finish: Chrome or Black

Table de salle à manger d'essence de bois. Plateau à bords arrondis, 4 pieds cylindriques avec structure métallique de liaison.
Finitions: Chêne Noir ou Chêne Naturel
Finition métal: Chrome ou Noir

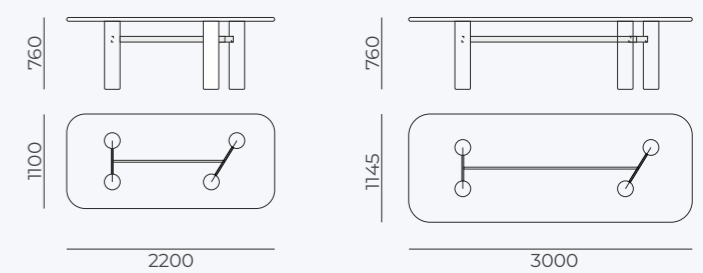

**VOLUMI BOLD, INDOLE COMPATTA, FORTE
VOCAZIONE MATERICA E UNA PRESENZA
SCENICA IMPONENTE E MAESTOSA.**

*CRONO è personalità allo stato puro, materia e
volumi che si fanno architettura.*

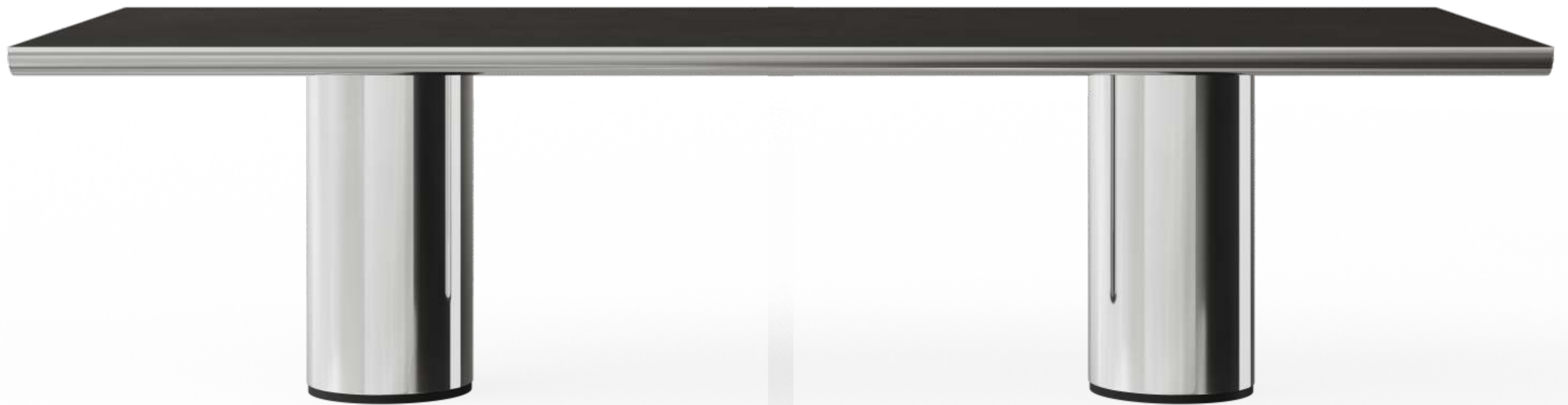

CRONO TAVOLO / DINING TABLE / TABLEAU

ACCIAIO LUCIDO - INSERTO MARMO, LEGNO, CERAMICA / POLISHED STEEL - MARBLE, WOOD, CERAMIC INSERT / ACIER POLI - MARBRE, BOIS, CÉRAMIQUE INSERT



LINEA GRANDE

CRONO

BOLD VOLUMES, A COMPACT CHARACTER, A STRONG MATERIAL VOCATION AND AN IMPOSING, MAJESTIC STAGE PRESENCE.

CRONO is personality in its purest state, matter and volumes that become architecture.



CRONO Tavolo da pranzo rettangolare con con gambe a cilindro, struttura in acciaio lucido. Inserto top - finitura extramat (fenix), marmo o legno.

CRONO Two-cylinder legs rectangular dining table with polished stainless steel structure. Top insert - extramat finish (Fenix), marble or wood.

CRONO Table de salle à manger rectangulaire avec pieds à deux cylindres et structure en acier poli. Plateau en extramat (Fenix), finition marbre ou bois.





LINEA **GRANDE**

PERSEO CONSOLE

DES VOLUMES AUDACIEUX, UN CARACTÈRE COMPACT, UNE VOCATION MATÉRIELLE FORTE ET UNE PRÉSENCE SCÉNIQUE IMPOSANTE ET MAJESTUEUSE.

CRONO- PERSEO, c'est la personnalité à l'état pur, la matière et les volumes qui deviennent architecture.



Console di acciaio lucido con gamba a cilindro. Struttura acciaio, finitura lucida, inserto top finitura extra mat (Fenix). Opzioni per inserto top: marmo, ceramica, legno.

Polished stainless steel console with cylinder leg. Structure in steel, polished finish, top insert in extra matte finish (Fenix). Options for top insert: marble, ceramic, wood.

Console en acier poli avec pied cylindrique. Structure en acier, finition polie, plateau extra mat (Fenix). Options du plateau : marbre, céramique, bois.



CRONO - PERSEO

COD.TCR

COD.CCR

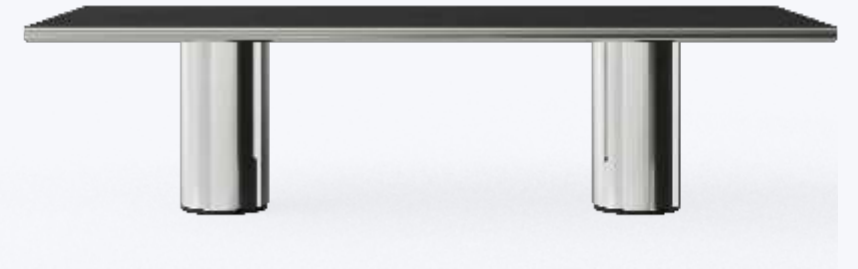

FINITURE | FINISHES

FINITURA DEL TOP
TOP FINISH
FINITION SUPÉRIEURE

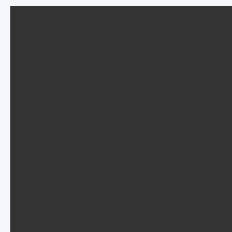

FX | FENIX



MQ | NERO MARQUINA

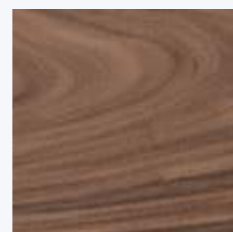

NC | NOCE CANALETTO

FINITURA STRUTTURA
STRUCTURE FINISH
FINITION DE LA STRUCTURE



GR | CHROME

DESCRIZIONE
DESCRIPTION
LA DESCRIPTION

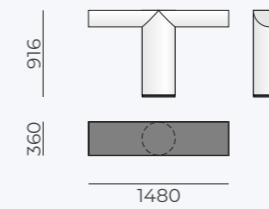
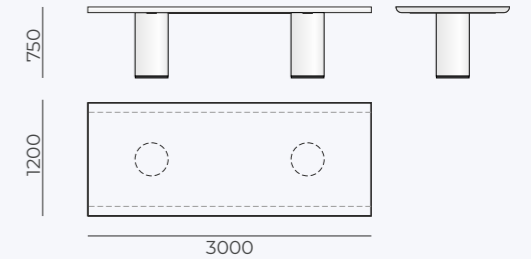



Table and console with cylinder-legs. Chrome finish structure, extra mat finish (Fenix) top insert. Options for top insert – marble, ceramic, wood.



Tavole e console con gambe a cilindro. Struttura finitura cromo, inserto top finitura extra mat (Fenix). Opzioni per inserto top: marmo, ceramica, legno.

Table avec pied cylindrique. Cadre en finition chromée, insert supérieur en finition extra mate (Fenix). Options pour le plateau : marbre, céramique, bois.



LINEARITÀ FLUIDA ED AVVOLGENTE,
ESPRESSIVITÀ VOLUMETRICA FUORI DAGLI
SCHEMI ED UNA CIFRA STILISTICA
IPNOTICA.

*MITO è il segno scultoreo che si
fa puro, al tempo stesso
progettualità e astrazione,
materia e idea.*

MITO TAVOLO / DINING TABLE / TABLEAU

ROVERE NERO FINITURA TOP, BASE LACCATA LUCIDA / OAK BLACK TOP FINISH, GLOSS LACQUER BASE / NOIR CHÊNE FINITION DU TOP, BASE LAQUE BRILLANTE



TOP CHIUSO / MITO / DESSUS FERME

LINEA GRANDE

MITO TABLE

**FLUID, ENVELOPING LINEARITY,
UNCONVENTIONAL
VOLUMETRIC EXPRESSIVENESS
AND A HYPNOTIC STYLISTIC
SIGNATURE.**

MITO is the sculptural sign that becomes pure, at once design and abstraction, material and idea.



Tavolo da pranzo con piano-trasformatore da 120x120 a 157x157 cm e gamba scultorea. Finitura: top rovere, gamba laccata opaca e lucida. Disponibile anche nella versione tavolino.

Dining table with top-transformer and sculptural lacquered legs. Finish: Oak top, Mat and Gloss finish Lacquered leg. Also available as a coffee table version.

Table avec plateau-transformateur de 120x120 à 157x157 cm et pied sculptural. Finition: plateau en chêne, pied laqué mat et brillant. Également disponible en version petite table.

TOP CHIUSO
CLOSED TOP
DESSUS FERME



TOP SEM APERTO
HALF-OPENED TOP
DESSUS SEMI-OUVERT



TOP APERTO
OPENED TOP
DESSUS OUVERT



UNE LINÉARITÉ FLUIDE ET ENVELOPPANTE,
UNE EXPRESSIVITÉ VOLUMÉTRIQUE NON
CONVENTIONNELLE ET UNE SIGNATURE
STYLISTIQUE HYPNOTIQUE.



MITO est le signe sculptural qui devient pur,
à la fois design et abstraction, matériau et idée.



MITO CANALETTO

NOCE CANALETTO - LACCATO OPACO O LUCIDO / BLACK WALNUT - MAT OR GLOSS LACQUER FINISH / NOYER CANALETTO - LAQUÉ



MITO CANALETTO



TAVOLINI / COFFEE TABLES



Tavolini con base scultorea.
Finiture: piano in vetro, ceramica o acciaio; base laccata opaca o lucida

Small tables with sculptural base. FINISHES: top in glass, ceramic or steel, base – matt or gloss lacquer.

Petites tables avec base sculpturale. FINITIONS : plateau en verre, céramique ou acier, base – laque mate ou brillante.

MITO

COD.TMT

COD.AMT

FINITURE | FINISHES

FINITURA DEL TOP
TOP FINISH
FINITION SUPÉRIEURE

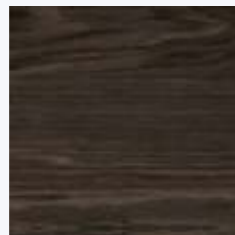

RN | ROVERE NERO

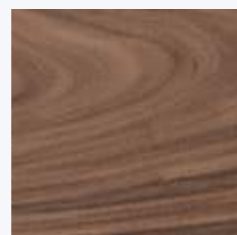

NC | NOCE CANALETTO

FINITURA GAMBA
LEG FINISH
FINITION JAMBE

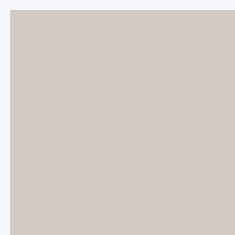

L0 | LACCATO OPACO



L2 | LACCATO LUCIDO

DESCRIZIONE
DESCRIPTION
LA DESCRIPTION

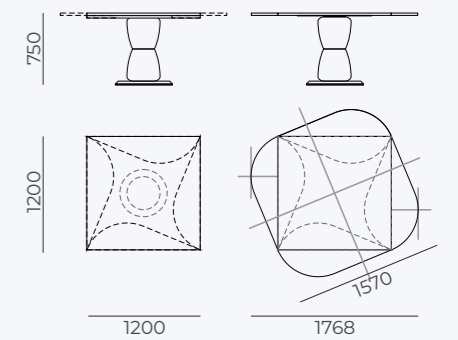

Tavolo con piano-
trasformatore da 120x120 a
157x157 cm e gamba scultorea.
Finitura: top rovere nero o
noce canaletto, gamba
laccata opaca e lucida.

Dining table with top-
transformer and sculptural
lacquered legs.
Finish: Oak top or Black
Walnut, Mat and Gloss
Lacquered leg.

Table avec plateau-
transformateur de 120x120 à
157x157 cm et pied sculptural.
Finition: plateau en chêne ou
noce canaletto, pied laqué
mat et brillant.



ERACLE TAVOLINI / SMALL TABLES / TABLEAUX

FINITURA LACCATA OPACA – INSERTO MARMO, CERAMICA O LEGNO / MATT LACQUERED FINISH - MARBLE, CERAMIC OR WOOD INSERT / FINITION LAQUÉE MATE - INSERT EN MARBRE

ERACLE

COD.GRD08

COD.GRD10



FINITURE | FINISHES

FINITURA DELLA STRUTTURA
STRUCTURE FINISH
FINITION DE LA STRUCTURE

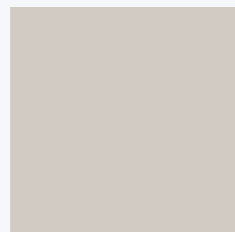

LO | GREIGE LACCATO OPACO



BR | BRONZE EFFECT PAINT

FINITURA INSERTI
INSERTS FINISH
FINITION des INSERTS

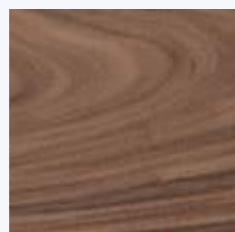

NC | NOCE CANALETTO

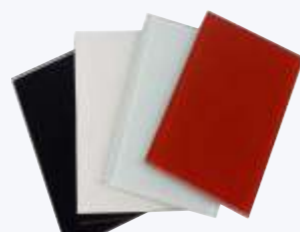

VL | VETRO LACCATO



MQ | NERO MARQUINA

DESCRIZIONE
DESCRIPTION
LA DESCRIPTION

Tavolino occasionale ovale e tavolino rotondo con bordi sagomati e arrotondati e inserti top in legno, marmo, ceramica o specchio. Struttura laccata in finitura opaca o lucida per le nostre opzioni.

Inserti top in Noce Canaletto, marmo naturale, ceramica o specchi colorati. Basamento in metallo verniciato liquido.

Occasional oval and round side tables with shaped rounded edges and top insert in wood, marble, ceramic or mirror. Lacquered structure in mat or gloss finish for our options.

Top insert in Black Walnut/ Noce Canaletto, natural marble, ceramic or colored mirror. Liquid-painted metal base.

Table d'appoint ovale et petite table ronde avec des bords façonnés et arrondis et des plateaux en bois, marbre, céramique ou miroir. Piètement laqué en finition mate ou brillante pour nos options.

Plateaux en noyer Canaletto, marbre naturel, céramique ou miroir coloré. Base en métal peint au liquide.

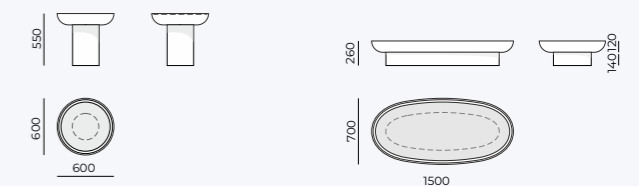



CRETA CONSOLLE/ CONSOLE

NOCE CANALETTO - ARABESCATO INSERTO MARMO / BLACK WALNUT - ARABESCATO MARBLE INSERT / NOYER CANALETTO - INSERT EN MARBRE ARABESQUE



CRETA CONSOLE



Console ovale realizzata in noce canaletto o in finitura laccata. Piano in marmo BIANCO DI CARRARA e inserti di legno.

Oval Console realized in Black Walnut/ Noce Canaletto or in lacquer finish with marble top Bianco Carrara and wooden insert.

Console ovale réalisée en noyer Canaletto ou en finition laquée. Plateau en marbre BIANCO DI CARRARA et inserts en bois

CRETA

COD.GRD05



FINITURE | FINISHES

FINITURA DELLA STRUTTURA
STRUCTURE FINISH
FINITION DE LA STRUCTURE

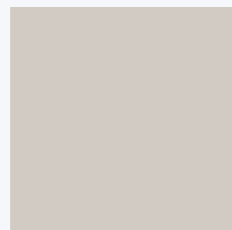

LO | LACCATO OPACO

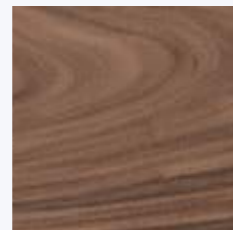

NC | NOCE CANALETTO

FINITURA INSERTI
INSERTS FINISH
FINITION des INSERTS

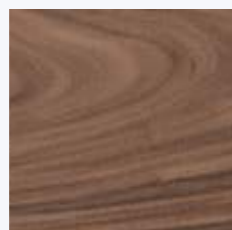

NC | NOCE CANALETTO



MB | MARMO

DESCRIZIONE
DESCRIPTION
LA DESCRIPTION

Consolle ovale CRETA con piano e gambe arrotondati. Struttura - Noce Canaletto o laccato opaco o lucido. Inserto top in marmo o inserto legno, finitura opaca o lucida.

CRETA Oval Console with rounded top and legs. Structure - Black Walnut/ Noce Canaletto or lacquered mat or gloss finish. Marble top insert or wooden top insert, mat or gloss finish-insert.

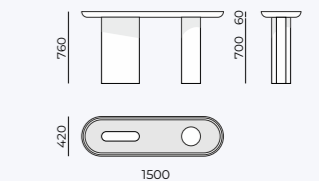

CRETA Console ovale avec plateau et pieds arrondis. Structure - Noyer noir/ Noce Canaletto ou laqué mat ou brillant. Plateau en marbre ou plateau en bois, finition mate ou brillante.

ULTRA MOBILI

IT ULTRAMOBILI è un brand d'avanguardia che celebra il design attraverso i suoi arredi icona, un universo integrato di complementi dalla forte vocazione architettonica e dall'identità profondamente contemporanea.

Gli arredi ULTRAMOBILI sono PROUDLY ULTRAMODERN, oggetti che vivono nel ritmo di oggi e nel tempo di domani. Tattilità dei materiali ed esclusività delle finiture, funzionalità avanzate e qualità senza compromessi definiscono l'indole e l'anima di ogni realizzazione, il migliore biglietto da visita con cui gli arredi ULTRAMOBILI si presentano al mondo.

Per essere ogni giorno di più PROUDLY ULTRAMODERN, PROUDLY ULTRAMOBILI.

EN ULTRAMOBILI is an avant-garde brand that celebrates design through its iconic furnishings, an integrated universe of complements with a strong architectural vocation and a deeply contemporary identity.

ULTRAMOBILI furnishings are PROUDLY ULTRAMODERN, objects that live in the rhythm of today and the time of tomorrow. Tactile materials and exclusive finishes, advanced functionality and uncompromising quality define the character and soul of each creation, the best business card with which ULTRAMOBILI furniture presents itself to the world.

To be every day more PROUDLY ULTRAMODERN, PROUDLY ULTRAMOBILE.

FR ULTRAMOBILI est une marque d'avant-garde qui célèbre le design à travers ses meubles iconiques, un univers intégré de compléments à forte vocation architecturale et une identité profondément contemporaine.

Les meubles ULTRAMOBILI sont FIERMENT ULTRAMODERNES, des objets qui vivent au rythme d'aujourd'hui et du temps de demain. Matériaux tactiles et finitions exclusives, fonctionnalité avancée et qualité sans compromis définissent le caractère et l'âme de chaque création, la meilleure carte de visite avec laquelle ULTRAMOBILI se présente au monde.

Pour être chaque jour plus PROUDLY ULTRAMODERN, PROUDLY ULTRAMOBILE.

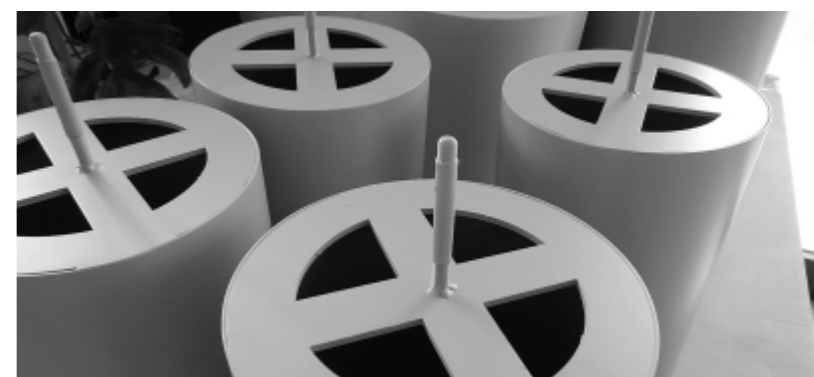

ULTRA
MOBILI

ULTRAMOBILI SRL

info@ultramobili.it
www.ultramobili.it

+39 0721 177 7240

LINEA **GRANDE!**
by **ULTRAMOBILI**
in-house design team

Per maggiori informazioni sui prodotti visitate il nostro sito web all'indirizzo www.ultramobili.it. Le descrizioni e le immagini relative ai prodotti sono indicative e non possono essere considerate vincolanti ai fini del loro utilizzo. ULTRAMOBILI si riserva di apportare modifiche, che ritiene più opportune, in qualsiasi momento e senza preavviso.

For more information about the products please visit our website at www.ultramobili.it. All descriptions and images included in the catalog are indicative and cannot be considered binding for the purposes of their use. ULTRAMOBILI reserves the right to make changes at any time and without notice.

Pour plus d'informations sur les produits, veuillez consulter notre site web à l'adresse suivante : www.ultramobili.it. Les descriptions et images des produits sont indicatives et ne peuvent être considérées comme contraignantes aux fins de leur utilisation. ULTRAMOBILI se réserve le droit d'apporter toutes les modifications qu'il juge opportunes, à tout moment et sans préavis.